

- RIBMNLB-2
- RIBLB-2

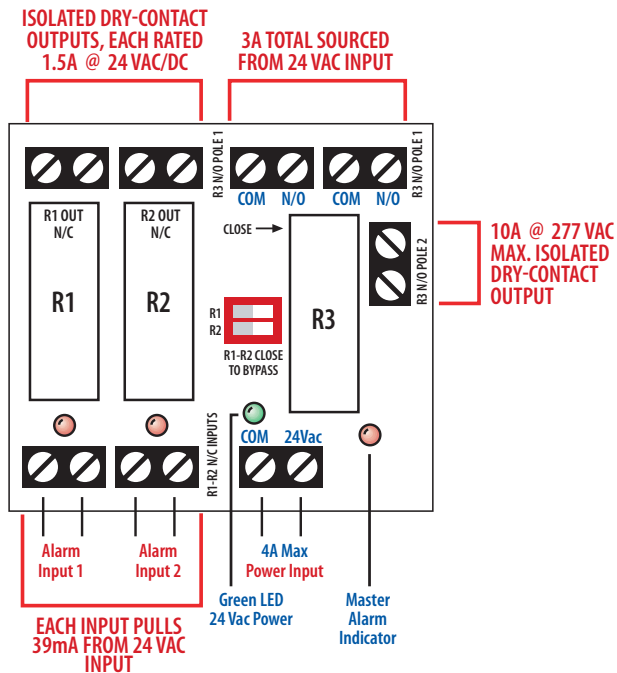

CAUTION: RISK OF ELECTRIC SHOCK - MORE THAN ONE DISCONNECT MAY BE REQUIRED TO DEENERGIZE THE DEVICE BEFORE SERVICING.

FOR SUPPLY CONNECTIONS USE #14 AWG WIRES OR LARGER RATED FOR AT LEAST 75°C (167°F).

USE COPPER CONDUCTORS ONLY.

- RIBMNLB-2
- RIBLB-2

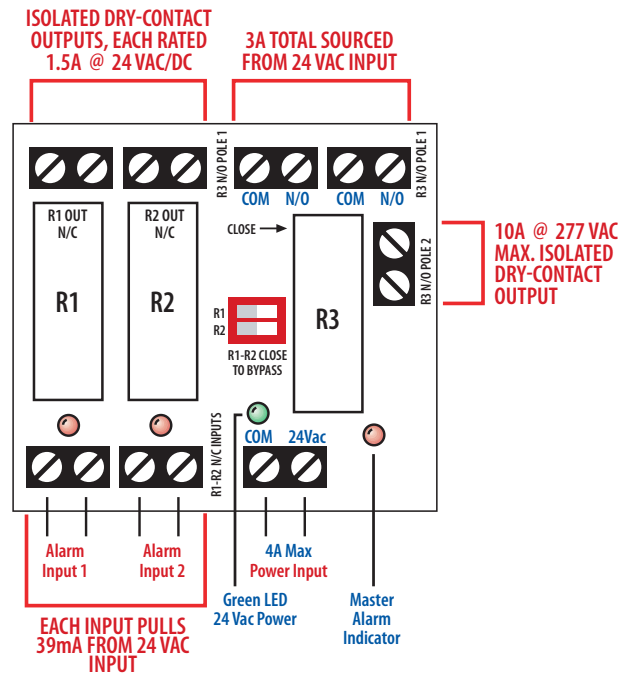

CAUTION: RISK OF ELECTRIC SHOCK - MORE THAN ONE DISCONNECT MAY BE REQUIRED TO DEENERGIZE THE DEVICE BEFORE SERVICING.

FOR SUPPLY CONNECTIONS USE #14 AWG WIRES OR LARGER RATED FOR AT LEAST 75°C (167°F).

USE COPPER CONDUCTORS ONLY.