



### POWER SUPPLY

- AC 100-120V / 200-240V Auto-select Input
- Width only 39mm
- Efficiency up to 95.2%
- Full Power Between -10°C and +55°C
- DC OK Relay Contact
- 3 Year Warranty

### PRODUCT DESCRIPTION

These PIANO series units are extraordinarily compact, industrial grade power supplies that focus on the essential features needed in today's industrial applications. The excellent cost/performance ratio presents many new and exciting opportunities without compromising quality or reliability.

The mechanically robust housing is made of a high-grade, reinforced molded material, which permits the units to be used in surrounding temperatures up to 70°C.

The unit is equipped with an auto-select input voltage stage for 100-120V and 200-240V mains systems, many safety approvals and a wide operational temperature range, which makes the unit applicable for global use.

The addition of a DC OK signal makes the unit suitable for many industry applications such as process control, factory automation or many other critical applications, where preventive function monitoring can help to avoid long downtimes.

### SHORT-FORM DATA

Output voltage	DC 24V	Nominal
Adjustment range	24 – 28V	Factory setting 24.1V
Output current	For AC 110-120V, AC 208-240V mains: 5.0 – 4.3A 3.1 – 2.7A	Below +55°C amb. At +70°C amb.
	For AC 100, 120V mains: 5.0 – 4.3A 2.5 – 2.1A	Below +50°C amb. At +70°C amb.
	Derate linearly between +50°C and +70°C	
Input voltage AC	AC 100-120V / 200-240V	±10%, Auto-select
Mains frequency	50-60Hz	±6%
AC Input current	1.72 / 1.05A	At 120 / 230Vac
Power factor	0.64 / 0.54	At 120 / 230Vac
AC Inrush current	22 / 33A pk	At 120 / 230Vac, 40°C, cold start
Efficiency	91.2 / 92.3%	At 120 / 230Vac
Losses	11.6 / 10.0W	At 120 / 230Vac
Hold-up time	51 / 50ms	At 120 / 230Vac
Temperature range	-25 to +70°C	
Size (WxHxD)	39x124x124mm	
Weight	370g / 0.81lb	

### ORDER NUMBERS

Power Supply	<b>PIC120.241D</b>	
Accessory	PIRD20.241	Redundancy module
	UF20.241	Buffer Module

### MAIN APPROVALS

**IECEE**  
CB SCHEME  
IEC 61010-2-201

**UL** US LISTED  
UL 61010-2-201

**IECEE**  
CB SCHEME  
IEC 62368-1



### INDEX

	Page		Page
1. Intended Use .....	3	17. Safety and Protection Features.....	14
2. Installation Instructions .....	3	18. Dielectric Strength.....	15
3. AC-Input.....	4	19. Approvals and Fulfilled Standards.....	16
4. DC-Input.....	5	20. Regulatory Compliance.....	16
5. Input Inrush Current .....	5	21. Physical Dimensions and Weight.....	17
6. Output .....	6	22. Accessory.....	18
7. Hold-up Time.....	7	22.1. PIRD20.241 Redundancy Module.....	18
8. DC OK Relay Contact.....	8	22.2. UF20.241 Buffer module .....	18
9. Efficiency and Power Losses.....	9	23. Application Notes.....	19
10. Functional Diagram.....	10	23.1. Charging of Batteries .....	19
11. Front Side and User Elements.....	10	23.2. Series Operation .....	19
12. Connection Terminals .....	11	23.3. Parallel Use to Increase Output Power....	19
13. Lifetime Expectancy .....	11	23.4. Parallel Use for 1+1 Redundancy.....	19
14. MTBF .....	11	23.5. Operation on Two Phases .....	20
15. EMC.....	12	23.6. Use in a Tightly Sealed Enclosure .....	20
16. Environment.....	13		

The information given in this document is correct to the best of our knowledge and experience at the time of publication. If not expressly agreed otherwise, this information does not represent a warranty in the legal sense of the word. As the state of our knowledge and experience is constantly changing, the information in this data sheet is subject to revision. We therefore kindly ask you to always use the latest issue of this document (available under [www.pulspower.com](http://www.pulspower.com)).

No part of this document may be reproduced or utilized in any form without our prior permission in writing.

Packaging and packaging aids can and should always be recycled. The product itself may not be disposed of as domestic refuse.

### TERMINOLOGY AND ABBREVIATIONS

<b>PE and <math>\oplus</math> symbol</b>	PE is the abbreviation for <b>Protective Earth</b> and has the same meaning as the symbol $\oplus$ .
<b>Earth, Ground</b>	This document uses the term "earth" which is the same as the U.S. term "ground".
<b>T.b.d.</b>	To be defined, value or description will follow later.
<b>AC 230V</b>	A figure displayed with the AC or DC before the value represents a nominal voltage with standard tolerances included. E.g.: DC 12V describes a 12V battery disregarding whether it is full (13.7V) or flat (10V)
<b>230Vac</b>	A figure with the unit (Vac) at the end is a momentary figure without any additional tolerances included.
<b>50Hz vs. 60Hz</b>	As long as not otherwise stated, AC 100V and AC 230V parameters are valid at 50Hz mains frequency. AC 120V parameters are valid for 60Hz mains frequency.
<b>may</b>	A key word indicate flexibility of choice with no implied preference.
<b>shall</b>	A key word indicate a mandatory requirement.
<b>should</b>	A key word indicate flexibility of choice with a strongly preferred implementation.

## 1. INTENDED USE

This device is designed for installation in an enclosure and is intended for commercial use, such as in industrial control, process control, monitoring, measurement, Audio/Video, information or communication equipment or the like. Do not use this device in equipment where malfunction may cause severe personal injury or threaten human life.

If this device is used in a manner outside of its specification, the protection provided by the device may be impaired.

Without additional measures to reduce the conducted emissions on the output (e.g. by using a filter), the device is not suited to supply a local DC power network in industrial, residential, commercial and light-industrial environments.

## 2. INSTALLATION INSTRUCTIONS

**⚠ WARNING** Risk of electrical shock, fire, personal injury or death.

- Turn power off before working on the device. Protect against inadvertent re-powering.
- Do not modify or repair the unit.
- Do not open the unit as high voltages are present inside.
- Use caution to prevent any foreign objects from entering the housing.
- Do not use in wet locations or in areas where moisture or condensation can be expected.
- Do not touch during power-on, and immediately after power-off. Hot surfaces may cause burns.

### Obey the following installation instructions:

This device may only be installed and put into operation by qualified personnel.

This device does not contain serviceable parts. The tripping of an internal fuse is caused by an internal defect.

If damage or malfunction should occur during installation or operation, immediately turn power off and send unit to the factory for inspection.

Install device in an enclosure providing protection against electrical, mechanical and fire hazards. Install the device onto a DIN-rail according to EN 60715 with the input terminals on the bottom of the device.

Make sure that the wiring is correct by following all local and national codes. Use appropriate copper cables that are designed for a minimum operating temperature of 60°C for ambient temperatures up to +45°C, 75°C for ambient temperatures up to +55°C and 90°C for ambient temperatures up to +70°C. Ensure that all strands of a stranded wire enter the terminal connection. Unused screw terminals should be securely tightened.

The device is designed for pollution degree 2 areas in controlled environments. No condensation or frost is allowed.

The enclosure of the device provides a degree of protection of IP20. The enclosure does not provide protection against spilled liquids.

The isolation of the device is designed to withstand impulse voltages of overvoltage category III according to IEC 60664-1.

The device is designed as "Class of Protection" I equipment according to IEC 61140. Do not use without a proper PE (Protective Earth) connection.

The device is suitable to be supplied from TN, TT or IT mains networks. The continuous voltage between the input terminal and the PE potential must not exceed 300Vac.

A disconnecting means shall be provided for the input of the device.

The device is designed for convection cooling and does not require an external fan. Do not obstruct airflow and do not cover ventilation grid!

The device is designed for altitudes up to 5000m (16400ft). Above 2000m (6560ft) the overvoltage category is reduced to level II and a reduction in output current is required.

Keep the following minimum installation clearances: 40mm on top, 20mm on the bottom, 5mm left and right side.

Increase the 5mm to 15mm in case the adjacent device is a heat source. When the device is permanently loaded with less than 50%, the 5mm can be reduced to zero.

The device is designed, tested and approved for branch circuits up to 20A without additional protection device. For higher branch circuits use an additional protection device. If an external input protection device is utilized, do not use one smaller than a 10A B- or C-characteristic to avoid a nuisance tripping of the circuit breaker.

The maximum surrounding air temperature is +70°C (+158°F). The operational temperature is the same as the ambient or surrounding air temperature and is defined 2cm below the device.

The device is designed to operate in areas between 5% and 95% relative humidity.

### 3. AC-INPUT

The device is suitable to be supplied from TN, TT or IT mains networks with AC voltage.

AC input	Nom.	AC 100-120V / 200-240V	Auto-select
AC input range		90-132Vac / 180- 264Vac 264-300Vac	Continuous operation Occasionally for maximal 500ms
Allowed voltage L or N to earth	Max.	300Vac	Continuous, according to IEC 60664-1
Input frequency	Nom.	50–60Hz	±6%
External input protection		See recommendations in chapter 2.	

		AC 100V	AC 120V	AC 230V	
Input current	Typ.	2.0A	1.72A	1.05A	At 24V, 5A, see Fig. 3-3
Power factor	Typ.	0.66	0.64	0.54	At 24V, 5A, see Fig. 3-4
Crest factor	Typ.	2.7	2.8	3.4	At 24V, 5A, The crest factor is the mathematical ratio of the peak value to RMS value of the input current waveform.
Turn-on voltage	Typ.	78Vac	78Vac	157Vac	Steady-state value, see Fig. 3-1
Shut-down voltage	Typ.	68Vac	68Vac	68Vac	At 24V, 5A, steady-state value, see Fig. 3-1
Start-up delay	Typ.	400ms	400ms	100ms	See Fig. 3-2
Rise time	Typ.	30ms	30ms	30ms	At 24V, 5A const. current load, 0mF load capacitance, see Fig. 3-2
	Typ.	90ms	90ms	90ms	At 24V, 5A const. current load, 5mF load capacitance, see Fig. 3-2
Turn-on overshoot	Max.	200mV	200mV	200mV	See Fig. 3-2

Fig. 3-1 Input voltage range, typ.

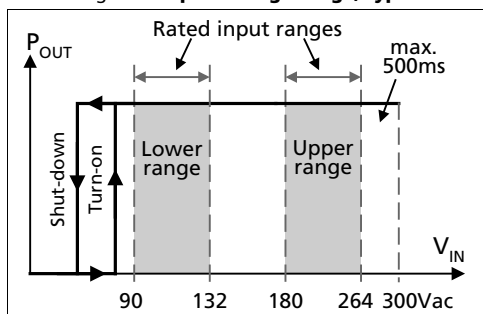

Fig. 3-3 Input current vs. output load at 24V

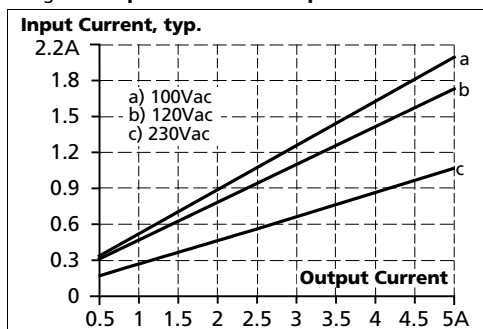

Fig. 3-2 Turn-on behaviour, definitions

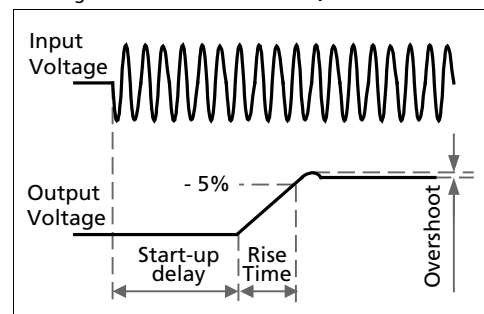
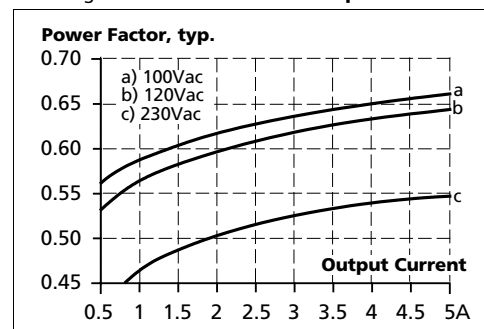

Fig. 3-4 Power factor vs. output load



### 4. DC-INPUT

Do not operate this power supply with DC-input voltage.

### 5. INPUT INRUSH CURRENT

An NTC inrush limiter limits the input inrush current after turn-on of the input voltage. The charging current into EMI suppression capacitors is disregarded in the first microseconds after switch-on.

		AC 100V	AC 120V	AC 230V	
Inrush current	Max.	23A <sub>peak</sub>	27A <sub>peak</sub>	40A <sub>peak</sub>	At 40°C, cold start
	Typ.	13A <sub>peak</sub>	16A <sub>peak</sub>	30A <sub>peak</sub>	At 25°C, cold start
	Typ.	18A <sub>peak</sub>	22A <sub>peak</sub>	33A <sub>peak</sub>	At 40°C, cold start
Inrush energy	Max.	0.4A <sup>2</sup> s	0.5A <sup>2</sup> s	1.5A <sup>2</sup> s	At 40°C, cold start

Fig. 5-1 Input inrush current, typical behavior  
230Vac input, 24V 5A output, 40°C ambient

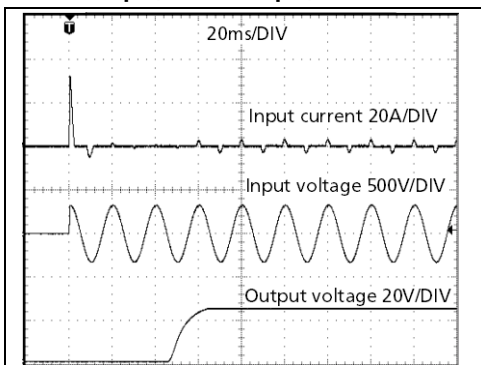
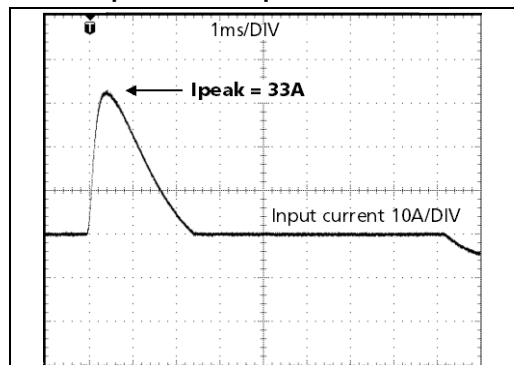

Fig. 5-2 Input inrush current, zoom into first peak  
230Vac input, 24V 5A output, 40°C ambient



### 6. OUTPUT

The output provides a SELV/PELV/ES1 rated voltage, which is galvanically isolated from the input voltage.

The output is designed to supply any kind of loads, including capacitive and inductive loads. The output can supply any kind of loads, including unlimited inductive and capacitive loads. If capacitors with a capacitance >10mF and 2.5A or >5mF with 5A additional current load are connected, the unit might charge the capacitor in an intermittent mode. No limitation for capacitive loads in combination with an additional resistive type of load.

The output is electronically protected against overload, no-load and short-circuits. In case of a protection event, audible noise may occur.

Output voltage	Nom.	DC 24V	
Adjustment range		24-28V	Guaranteed value
	Max.	30V	This is the maximum output voltage which can occur at the clockwise end position of the potentiometer due to tolerances. It is not a guaranteed value which can be achieved.
Factory settings	Typ.	24.1V	±0.2%, at full load and cold unit
Line regulation	Max.	10mV	Between 85 and 300Vac
Load regulation	Max.	150mV	Between 0A and 5A, static value, see Fig. 6-1
Ripple and noise voltage	Max.	100mVpp	Bandwidth 20Hz to 20MHz, 50Ohm
Output current	Nom.	5.0A	At 24V and an ambient temperature below 55°C
	Nom.	3.1A	At 24V and 70°C ambient temperature
	Nom.	4.3A	At 28V and an ambient temperature below 55°C
	Nom.	2.7A	At 28V and 70°C ambient temperature
		Derate linearly between +55°C and +70°	
Overload behaviour	Continuous current		For output voltage above 2...10Vdc (depending on the input voltage), see Fig. 6-1
	Intermittent current <sup>1)</sup>		For output voltage below 2...10Vdc (depending on the input voltage), see Fig. 6-1
Overload/ short-circuit current	Max.	9.8A	Continuous current, see Fig. 6-1
	Typ.	9.2A	Intermittent current peak value for typ. 60ms Load impedance 50mOhm, see Fig. 6-2 Discharge current of output capacitors is not included.
	Max.	3.5A	Intermittent current average value (R.M.S.) Load impedance 50mOhm, see Fig. 6-2
Output capacitance	Typ.	2 050µF	Included inside the power supply
Back-feeding loads	Max.	35V	The unit is resistant and does not show malfunctioning when a load feeds back voltage to the power supply. It does not matter whether the power supply is on or off. The absorbing energy can be calculated according to the built-in large sized output capacitor.

1) At heavy overloads (when output voltage falls below 2...10V, depending on the input voltage), the power supply delivers output current for 60ms. After this, the output is switched off for 360ms before a new start attempt is automatically performed. This cycle is repeated as long as the overload exists. If the overload has been cleared, the device will operate normally.

Fig. 6-1 Output voltage vs. output current, typ.

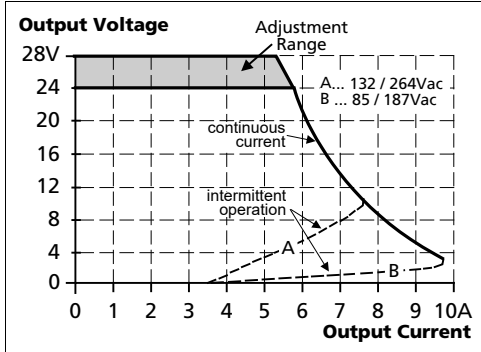
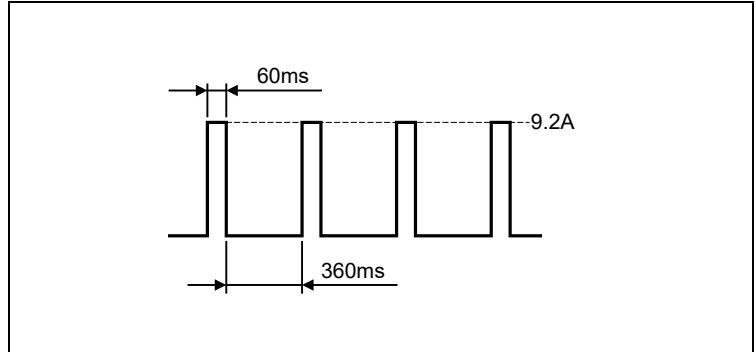

Fig. 6-2 Intermittent operation at shorted output, typ.



## 7. HOLD-UP TIME

The hold-up time is the time during which a power supply's output voltage remains within specification following the loss of input power. The hold-up time is output load dependent. At no load, the hold-up time can be up to several seconds. The green DC OK lamp is also on during this time.

		AC 100V	AC 120V	AC 230V	
Hold-up Time	Typ.	64ms	108ms	105ms	At 24V, 2.5A, see Fig. 7-1
	Min.	54ms	91ms	88ms	At 24V, 2.5A, see Fig. 7-1
	Typ.	26ms	51ms	50ms	At 24V, 5A, see Fig. 7-1
	Min.	22ms	43ms	42ms	At 24V, 5A, see Fig. 7-1

Fig. 7-1 Hold-up time vs. input voltage

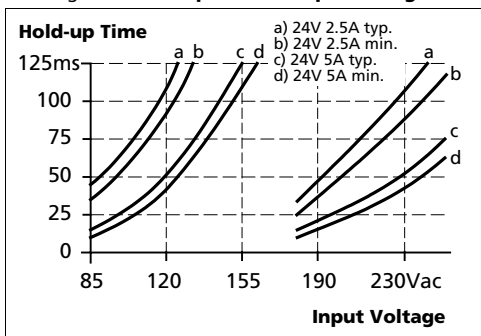
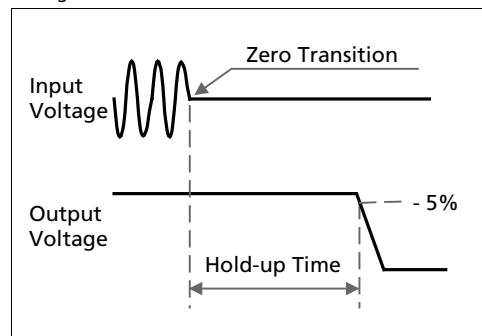

Fig. 7-2 Shut-down behaviour, definitions



### 8. DC OK RELAY CONTACT

This feature monitors the output voltage on the output terminals of a running power supply.

Contact closes	As soon as the output voltage reaches 22V.
Contact opens	As soon as the output voltage falls below 22V.
Switching hysteresis	Typically, 0.7V
Contact ratings	Maximal 60Vdc 0.3A, 30Vdc 1A, 30Vac 0.5A, resistive load Minimal permissible load: 1mA at 5Vdc
Isolation voltage	See dielectric strength table in section 18.

Fig. 8-1 DC OK relay contact behavior

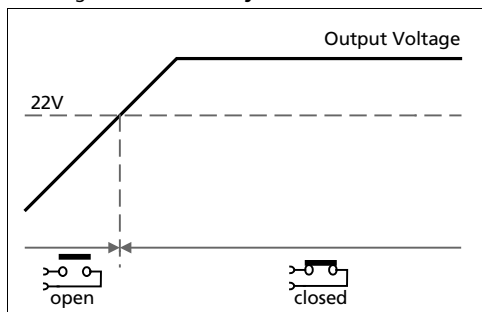



### 9. EFFICIENCY AND POWER LOSSES

		AC 100V	AC 120V	AC 230V	
Efficiency	Typ.	90.7%	91.2%	92.3%	At 24V, 5A
Average efficiency*)	Typ.	89.2%	89.4%	90.6%	25% at 1.25A, 25% at 2.5A, 25% at 3.75A, 25% at 5A
Power losses	Typ.	1.4W	1.5W	0.7W	At 24V, 0A
	Typ.	7.0W	7.4W	6.0W	At 24V, 2.5A
	Typ.	12.3W	11.6W	10.0W	At 24V, 5A

\*) The average efficiency is an assumption for a typical application where the power supply is loaded with 25% of the nominal load for 25% of the time, 50% of the nominal load for another 25% of the time, 75% of the nominal load for another 25% of the time and with 100% of the nominal load for the rest of the time.

Fig. 9-1 Efficiency vs. output current at 24V, typ.

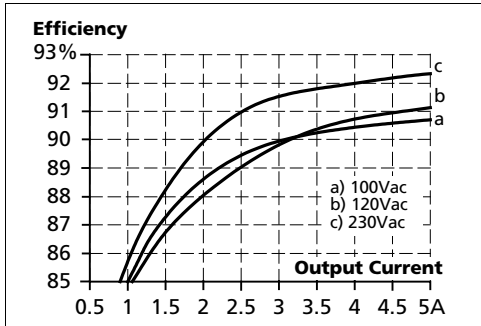

Fig. 9-2 Losses vs. output current at 24V, typ.

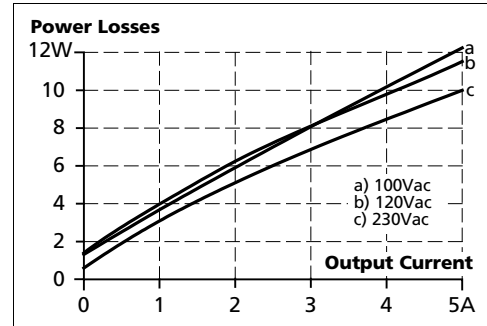

Fig. 9-3 Efficiency vs. input voltage at 24V, 5A, typ.

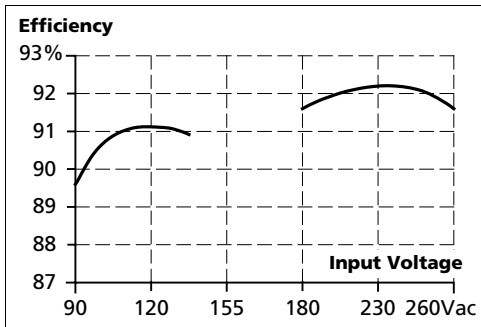
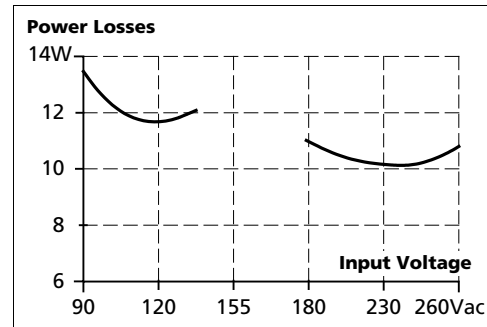
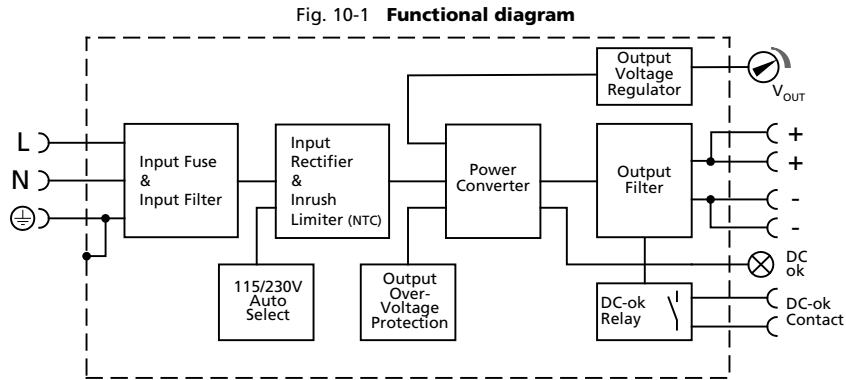

Fig. 9-4 Losses vs. input voltage at 24V, 5A, typ.



### 10. FUNCTIONAL DIAGRAM



### 11. FRONT SIDE AND USER ELEMENTS

Fig. 11-1 **Front side**

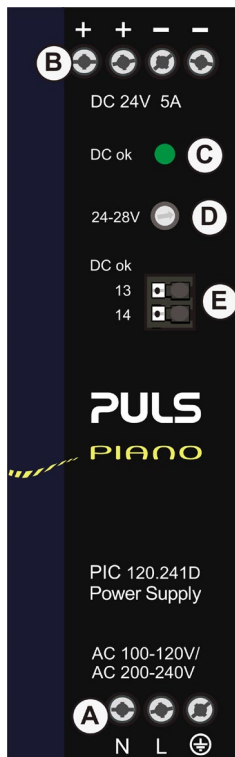

#### **A Input Terminals**

- N, L** Line input
- PE (Protective Earth) input

#### **B Output Terminals**

- Two identical + poles and two identical - poles
- +** Positive output
- Negative (return) output

#### **C DC OK LED (green)**

- On, when the output voltage is above 18V.

#### **D Output Voltage Adjustment Potentiometer**

#### **E DC OK Relay Contact**

- The DC OK relay contact is not synchronized with the DC OK LED.
- See chapter 8 for details.

### 12. CONNECTION TERMINALS

The terminals are IP20 finger safe constructed and suitable for field- and factory wiring.

	Input	Output	DC OK-Signal
Type	Screw termination	Screw termination	Push-in termination
Solid wire	Max. 6mm <sup>2</sup>	Max. 6mm <sup>2</sup>	Max. 1.5mm <sup>2</sup>
Stranded wire	Max. 4mm <sup>2</sup>	Max. 4mm <sup>2</sup>	Max. 1.5mm <sup>2</sup>
American Wire Gauge	AWG 20-10	AWG 20-10	AWG 24-16
Max. wire diameter (including ferrules)	2.8mm	2.8mm	1.6mm
Recommended tightening torque	Max. 1Nm, 9lb-in	Max. 1Nm, 9lb-in	-
Wire stripping length	7mm / 0.28inch	7mm / 0.28inch	7mm / 0.28inch
Screwdriver	3.5mm slotted or crosshead No 2	3.5mm slotted or crosshead No 2	3mm slotted to open the spring

### 13. LIFETIME EXPECTANCY

The Lifetime expectancy shown in the table indicates the minimum operating hours (service life) and is determined by the lifetime expectancy of the built-in electrolytic capacitors. Lifetime expectancy is specified in operational hours and is calculated according to the capacitor's manufacturer specification. The manufacturer of the electrolytic capacitors only guarantees a maximum life of up to 15 years (131 400h). Any number exceeding this value is a calculated theoretical lifetime which can be used to compare devices.

	AC 100V	AC 120V	AC 230V	
Lifetime expectancy	66 000h	68 000h	83 000h	At 24V, 5A and 40°C
	181 000h	194 000h	219 000h	At 24V, 2.5A and 40°C
	188 000h	193 000h	234 000h	At 24V, 5A and 25°C
	511 000h	548 000h	621 000h	At 24V, 2.5A and 25°C

### 14. MTBF

MTBF stands for **Mean Time Between Failure**, which is calculated according to statistical device failures, and indicates reliability of a device. It is the statistical representation of the likelihood of a unit to fail and does not necessarily represent the life of a product.

The MTBF figure is a statistical representation of the likelihood of a device to fail. A MTBF figure of e.g. 1 000 000h means that statistically one unit will fail every 100 hours if 10 000 units are installed in the field. However, it can not be determined if the failed unit has been running for 50 000h or only for 100h.

For these types of units, the MTTF (**Mean Time To Failure**) value is the same value as the MTBF value.

	AC 100V	AC 120V	AC 230V	
MTBF SN 29500, IEC 61709	1 065 000h	1 147 000h	1 379 000h	At 24V, 5A and 40°C
	2 038 000h	2 166 000h	2 519 000h	At 24V, 5A and 25°C
MTBF MIL HDBK 217F	681 000h	651 000h	645 000h	At 24V, 5A and 40°C, Ground Benign GB40
	872 000h	842 000h	839 000h	At 24V, 5A and 25°C, Ground Benign GB25
	165 000h	164 000h	168 000h	At 24V, 5A and 40°C, Ground Fixed GF40
	206 000h	205 000h	211 000h	At 24V, 5A and 25°C, Ground Fixed GF25

### 15. EMC

The EMC behavior of the device is designed for applications in industrial environment as well as in residential, commercial and light industry environments.

The device complies with EN 61000-6-1, EN 61000-6-2, EN 61000-6-3, EN 61000-6-4, EN 61000-3-2 and EN 61000-3-3.

This device complies with FCC Part 15 rules. Operation is subjected to following two conditions: (1) this device may not cause harmful interference, and (2) this device must accept any interference received, including interference that may cause undesired operation.

Without additional measures to reduce the conducted emissions on the output (e.g. by using a filter), the device is not suited to supply a local DC power network in industrial, residential, commercial and light-industrial environments.

#### EMC Immunity

Electrostatic discharge	EN 61000-4-2	Contact discharge	8kV	Criterion A
		Air discharge	8kV	Criterion A
Electromagnetic RF field	EN 61000-4-3	80MHz-2.7GHz	20V/m	Criterion A
Fast transients (Burst)	EN 61000-4-4	Input lines	4kV	Criterion A
		Output lines	2kV	Criterion A
		DC OK signal (coupling clamp)	2kV	Criterion A
Surge voltage on input	EN 61000-4-5	L → N	2kV	Criterion A
		L → PE, N → PE	4kV	Criterion A
Surge voltage on output	EN 61000-4-5	+ → -	500V	Criterion A
		+ / - → PE	1kV	Criterion A
Surge voltage on DC OK	EN 61000-4-5	DC OK signal → PE	1kV	Criterion A
Conducted disturbance	EN 61000-4-6	0.15-80MHz	20V	Criterion A
Mains voltage dips	EN 61000-4-11	0% of 100Vac	0Vac, 20ms	Criterion A
		40% of 100Vac	40Vac, 200ms	Criterion C
		70% of 100Vac	70Vac, 500ms	below 4.5A Criterion A
		70% of 100Vac	70Vac, 500ms	above 4.5A Criterion C
		0% of 200Vac	0Vac, 20ms	Criterion A
		40% of 200Vac	80Vac, 200ms	Criterion C
70% of 200Vac	140Vac, 500ms	Criterion A		
Voltage interruptions	EN 61000-4-11	0V	5000ms	Criterion C
Powerful transients	VDE 0160	Over entire load range	750V, 1.3ms	Criterion A

#### Performance criterions:

**A:** The device shows normal operation behavior within the defined limits.

**C:** Temporary loss of function is possible. The device may shut down and restarts by itself. No damage or hazards for the device will occur.

#### EMC Emission

Conducted emission input lines	EN 55011, EN 55032, FCC Part 15, CISPR 11, CISPR 32	Class B
Conducted emission output lines	IEC/CISPR 16-1-2, IEC/CISPR 16-2-1	Limits for DC power port acc. EN 61000-6-3 not fulfilled
Radiated emission	EN 55011, EN 55032	Class B
Harmonic input current	EN 61000-3-2	Fulfilled, Class A limits
Voltage fluctuations, flicker	EN 61000-3-3	Fulfilled· tested with constant current loads, non pulsing

#### Switching frequencies:

Main converter	40kHz to 120kHz	Output voltage and load dependent, min. load 1A
----------------	-----------------	---

### 16. ENVIRONMENT

Operational temperature	-10°C to +70°C (14°F to 158°F)	Operational temperature is the same as the ambient or surrounding temperature and is defined as the air temperature 2cm below the unit.
Storage temperature	-40°C to +85°C (-40°F to 185°F)	For storage and transportation
Output de-rating	3W/°C 7.5W/1000m or 5°C/1000m The de-rating is not hardware controlled. The user has to take this into consideration to stay below the de-rated current limits in order not to overload the unit.	Between +55°C and +70°C (131°F to 140°F) For altitudes >2000m (6560ft), see Fig. 16-2
Humidity	5 to 95% r.h.	According to IEC 60068-2-30
Atmospheric pressure	110-54kPa	See Fig. 16-2 for details
Altitude	Up to 5000m (16 400ft)	See Fig. 16-2 for details
Over-voltage category	II	According to IEC 60664-1, for altitudes up to 5000m
Impulse withstand voltages	4kV (according to over-voltage category III)	Input to PE According to IEC 60664-1, for altitudes up to 2000m
Degree of pollution	2	According to IEC 60664-1, not conductive
Vibration sinusoidal	2-17.8Hz: ±1.6mm; 17.8-500Hz: 2g 2 hours / axis	According to IEC 60068-2-6
Shock	30g 6ms, 20g 11ms 3 bumps per direction, 18 bumps in total Shock and vibration is tested in combination with DIN-Rails according to EN 60715 with a height of 15mm and a thickness of 1.3mm and standard orientation.	According to IEC 60068-2-27
Audible noise	Some audible noise may be emitted from the power supply during no load, overload or short circuit.	

Fig. 16-1 Output current vs. ambient temp.

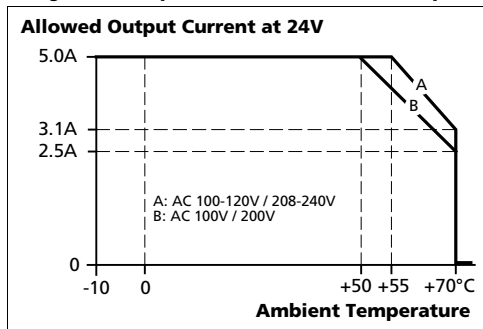
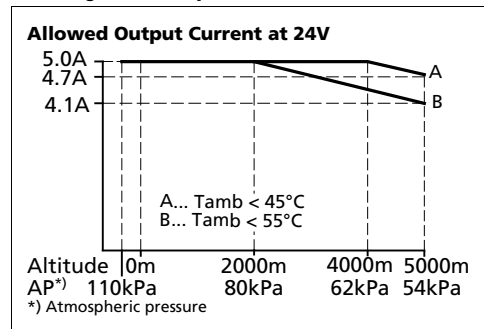

Fig. 16-2 Output current vs. altitude



### 17. SAFETY AND PROTECTION FEATURES

Isolation resistance	Min.	500MΩ	At delivered condition between input and output, measured with 500Vdc
	Min.	500MΩ	At delivered condition between input and PE, measured with 500Vdc
	Min.	500MΩ	At delivered condition between output and PE, measured with 500Vdc
	Min.	500MΩ	At delivered condition between output and DC OK contacts, measured with 500Vdc
Output over-voltage protection	Typ.	31.0Vdc	In case of an internal defect, a redundant circuit limits the maximum output voltage. The output shuts down. To attempt a restart, turn the input power off for at least 90s.
	Max.	34.0Vdc	
Class of protection		I	According to IEC 61140 A PE (Protective Earth) connection is required
Ingress protection		IP 20	According to EN/IEC 60529
Over-temperature protection		Not included	
Input transient protection		MOV (Metal Oxide Varistor)	For protection values see chapter 15 (EMC).
Internal input fuse		Included	Not user replaceable slow-blow high-braking capacity fuse
Touch current (leakage current)	Typ.	0.21mA / 0.46mA	At 100Vac, 50Hz, TN-,TT-mains / IT-mains
	Typ.	0.30mA / 0.65mA	At 120Vac, 60Hz, TN-,TT-mains / IT-mains
	Typ.	0.33mA / 0.72mA	At 230Vac, 50Hz, TN-,TT-mains / IT-mains
	Max.	0.27mA / 0.56mA	At 110Vac, 50Hz, TN-,TT-mains / IT-mains
	Max.	0.38mA / 0.78mA	At 132Vac, 60Hz, TN-,TT-mains / IT-mains
	Max.	0.43mA / 0.90mA	At 264Vac, 50Hz, TN-,TT-mains / IT-mains

### 18. DIELECTRIC STRENGTH

The output voltage is floating and has no ohmic connection to the ground.

The output is insulated to the input by a double or reinforced insulation.

Type and routine tests are conducted by the manufacturer. Field tests may be conducted in the field using the appropriate test equipment which applies the voltage with a slow ramp (2s up and 2s down). Connect all input-terminals together as well as all output poles before conducting the test. When testing, set the cut-off current settings to the value in the table below.

We recommend that either the + pole or the - pole shall be connected to the protective earth system. This helps to avoid situations in which a load starts unexpectedly or can not be switched off when unnoticed earth faults occur.

Fig. 18-1 Dielectric strength

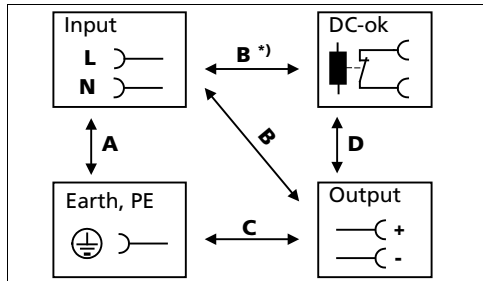





		A	B	C	D
Type test	60s	2500Vac	3000Vac	1000Vac	500Vac
Routine test	5s	2500Vac	2500Vac	500Vac	500Vac
Field test	5s	2000Vac	2000Vac	500Vac	500Vac
Field test cut-off current settings		> 10mA	> 10mA	> 15mA	> 1mA



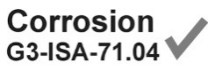

B\*)

When testing input to DC OK ensure that the maximal voltage between DC OK and the output is not exceeded (column D). We recommend connecting DC OK pins and the output pins together when performing the test.

### 19. APPROVALS AND FULFILLED STANDARDS

IEC 61010		CB Scheme Certificate IEC 61010-2-201 Electrical Equipment for Measurement, Control and Laboratory Use - Particular requirements for control equipment
UL 61010		UL Certificate Listed equipment for category NMTR - UL 61010-2-201 Electrical Equipment for Measurement, Control and Laboratory Use - Particular requirements for control equipment Applicable for US and Canada E-File: E198865
IEC 62368		CB Scheme Certificate IEC 62368-1 Audio/video, information and communication technology equipment - Safety requirements Output safety level: ES1
ISA-71.04-1985		Manufacturer's Declaration (Online Document) Airborne Contaminants Corrosion Test Severity Level: G3 Harsh H2S: 100ppb NOx: 1250ppb Cl2: 20ppb SO2: 300ppb Test Duration: 3 weeks, which simulates a service life of at least 10 years
VDMA 24364		Paint Wetting Impairment Substances Test (or LABS-Test) Tested for Zone 2 and test class C1 according to VDMA 24364-C1-L/W for solvents and water-based paints

### 20. REGULATORY COMPLIANCE

EU Declaration of Conformity		The CE mark indicates conformance with the - EMC directive - Low-voltage directive - RoHS directive
REACH Directive		Manufacturer's Statement EU-Regulation regarding the Registration, Evaluation, Authorisation and Restriction of Chemicals
WEEE Directive		Manufacturer's Statement EU-Regulation on Waste Electrical and Electronic Equipment Registered in Germany as business to business (B2B) products.
EAC TR Registration		EAC Certificate EAC EurAsian Conformity - Registration Russia, Kazakhstan and Belarus 8504408200, 8504409000



### 21. PHYSICAL DIMENSIONS AND WEIGHT

Width	39mm	1.54"
Height	124mm	4.88"
Depth	124mm	4.88"
	The DIN-rail height must be added to the unit depth to calculate the total required installation depth.	
Weight	370g / 0.81lb	
DIN-Rail	Use 35mm DIN-rails according to EN 60715 or EN 50022 with a height of 7.5 or 15mm.	
Plastic Material of Housing	Flame retardant Polycarbonate (PC) - UL94-V0 Vicat softening temperature specified with 149°C according to ASTM D1525	
Installation Clearances	See chapter 2	
Penetration protection	Small parts like screws, nuts, etc. with a diameter larger than 4mm	

Fig. 21-1 Front view

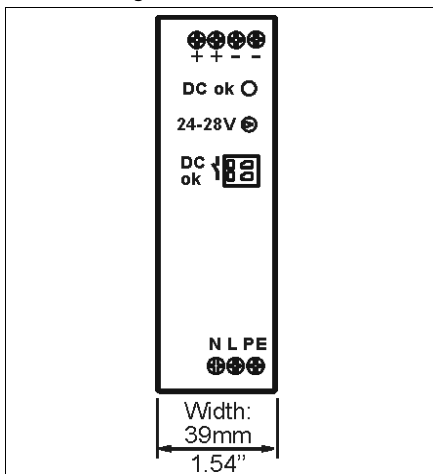
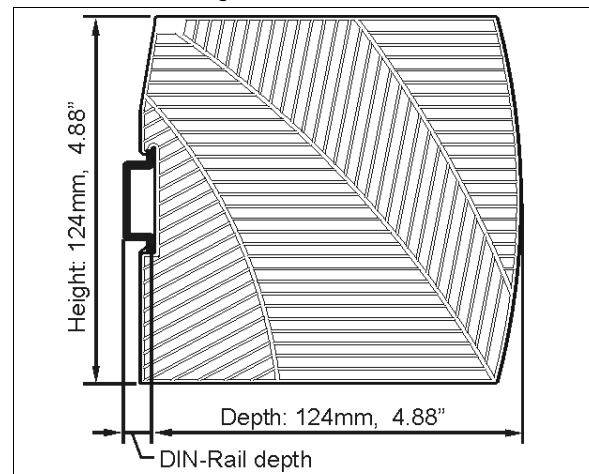

Fig. 21-2 Side view



## 22. ACCESSORY

### 22.1. PIRD20.241 REDUNDANCY MODULE



The PIRD20.241 is a dual redundancy module, which can be used to build 1+1 or N+1 redundant system.

The device is equipped with two 10A nominal input channels, which are individually decoupled by utilizing diode technology. The output can be loaded with a nominal 20A continuous current.

The device does not require an additional auxiliary voltage and is self-powered even in case of a short circuit across the output.

The unit is very narrow and only requires 39mm width on the DIN-rail.

See chapter 23.4 for wiring information.

### 22.2. UF20.241 BUFFER MODULE



The UF20.241 buffer module is a supplementary device for DC 24V power supplies. It delivers power to bridge typical mains failures or extends the hold-up time after the AC power is turned off.

When the power supply provides a sufficient voltage, the buffer module stores energy in the integrated electrolytic capacitors. When the mains voltage is lost, the stored energy is released to the DC-bus in a regulated process.

The buffer module can be added in parallel to the load circuit at any given point and does not require any control wiring.

One buffer module can deliver 20A additional current and can be added in parallel to increase the output ampacity or the hold-up time.

For longer hold-up times the UF40.241 might also be an option.

## 23. APPLICATION NOTES

### 23.1. CHARGING OF BATTERIES

Do not use the power supply to charge batteries.

### 23.2. SERIES OPERATION

Devices of the same type can be connected in series for higher output voltages. It is possible to connect as many units in series as needed, providing the sum of the output voltage does not exceed 150Vdc. Voltages with a potential above 60Vdc must be installed with a protection against touching.

Avoid return voltage (e.g. from a decelerating motor or battery) which is applied to the output terminals.

Keep an installation clearance of 15mm (left / right) between two power supplies and avoid installing the power supplies on top of each other. Do not use power supplies in series in mounting orientations other than the standard mounting orientation.

Pay attention that leakage current, EMI, inrush current, harmonics will increase when using multiple devices.

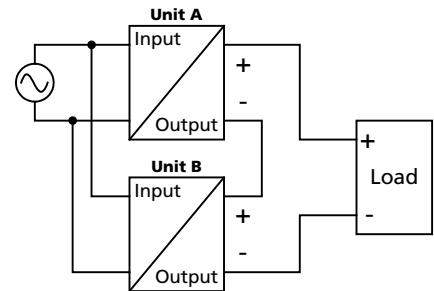

### 23.3. PARALLEL USE TO INCREASE OUTPUT POWER

Do not use the power supply in parallel to increase the output power.

### 23.4. PARALLEL USE FOR 1+1 REDUNDANCY

The device can be used to built 1+1 redundant systems.

#### 1+1 Redundancy:

Devices can be paralleled for redundancy to gain higher system availability. Redundant systems require a certain amount of extra power to support the load in case one device fails. The simplest way is to put two devices in parallel. This is called a 1+1 redundancy. In case one device fails, the other one is automatically able to support the load current without any interruption. It is essential to use a redundancy module to decouple devices from each other. This prevents that the defective unit becomes a load for the other device and the output voltage cannot be maintained any more.

1+1 redundancy allows ambient temperatures up to +70°C.

Pay attention that leakage current, EMI, inrush current, harmonics will increase when using multiple devices.

Recommendations for building redundant power systems:

- Use separate input fuses for each device.
- Use separate mains systems for each device whenever it is possible.
- Monitor the individual devices. Therefore, use the DC OK signal of the device.
- It is desirable to set the output voltages of all devices to the same value ( $\pm 100\text{mV}$ ) or leave it at the factory setting.

### Wiring examples:

Fig. 23-1 1+1 Redundant wiring with a PIRD20.241 redundancy module

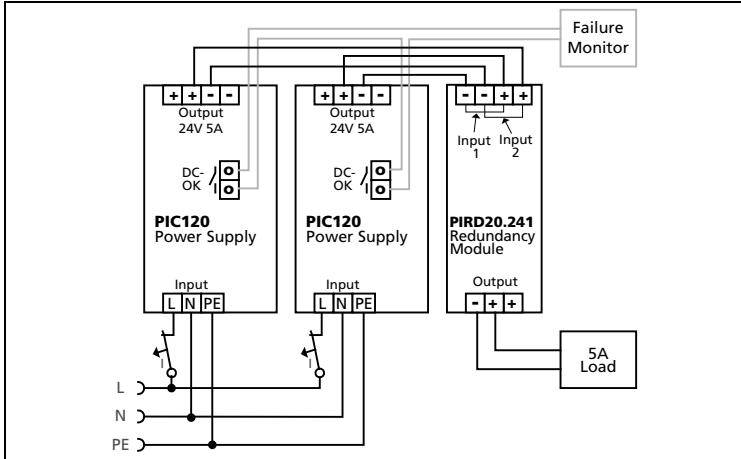

### 23.5. OPERATION ON TWO PHASES

The power supply can also be used on two-phases of a three-phase-system. Such a phase-to-phase connection is allowed as long as the supplying voltage is below  $240V_{+10\%}$ .

Ensure that the wire, which is connected to the N-terminal, is appropriately fused.

The maximum allowed voltage between a Phase and the PE must be below 300Vac.

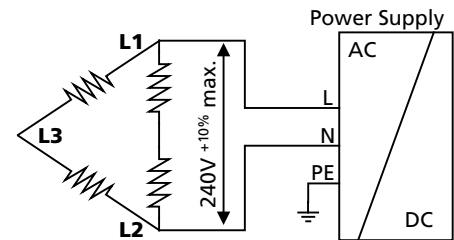

### 23.6. USE IN A TIGHTLY SEALED ENCLOSURE

When the power supply is installed in a tightly sealed enclosure, the temperature inside the enclosure will be higher than outside. In such situations, the inside temperature defines the ambient temperature for the power supply.

The following measurement results can be used as a reference to estimate the temperature rise inside the enclosure.

The power supply is placed in the middle of the box, no other heat producing items are inside the box

The temperature sensor inside the box is placed in the middle of the right side of the power supply with a distance of 1cm.

The following measurement results can be used as a reference to estimate the temperature rise inside the enclosure.

	Case A	Case B
Enclosure size	110x180x165mm Rittal Typ IP66 Box PK 9516 100, plastic	110x180x165mm Rittal Typ IP66 Box PK 9516 100, plastic
Input voltage	230Vac	230Vac
Load	24V, 4A; (=80%)	24V, 5A; (=100%)
Temperature inside the box	35.5°C	38.1°C
Temperature outside the box	21.0°C	21.0°C
Temperature rise	14.5K	17.1K